

Anslutningsmått

Standardkonsol

	A	B	C
10	41	73	59
11	63	95	32
21	58	91	25
22	75	125	25
33	75	180	25

Skolkonsol

	A	B	C
10	41	73	59
11	95	127	64
21	92	125	59
22	109	159	59
33	109	214	59

- A Mått vägg C/C rör
- B Totalmått
- C Från vägg till bakkant radiator

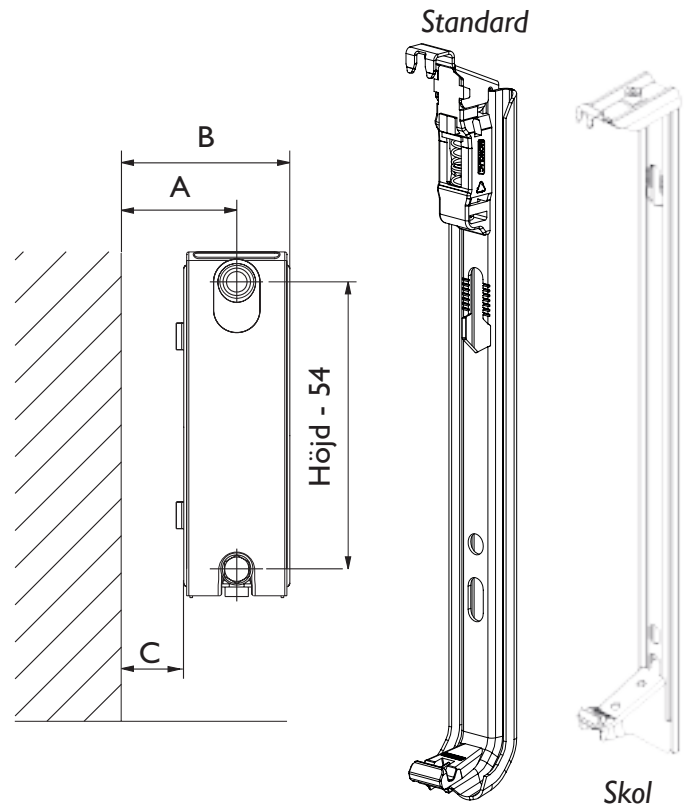

OBS! Alla mått är i mm. Med planfront ökar djupet på 2mm

Anslutningsmått koppel

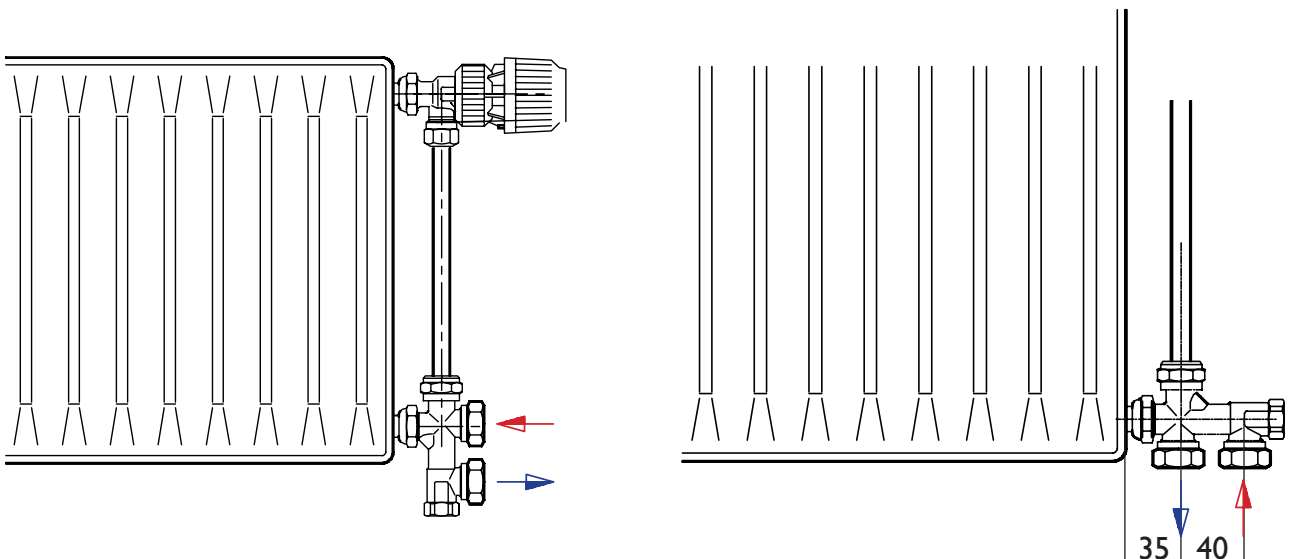

Borrmått för konsoler i mm

Höjd	TYP I0		TYP II		TYP 21, 22, 33	
	B1	B2	B1	B2	B1	B2
200					27	80
300	60	190	68	154	67	198
400	60	290	68	254	67	298
500	60	390	68	354	67	398
600	60	490	68	454	67	498
700	60	590	68	554	67	598
900	60	790	68	754	67	798

Skolkonsol

300	40	218
400	40	318
500	40	418
600	40	518
700	40	618
900	40	818

